

International Conference on Space Optics—ICSO 2006

Noordwijk, Netherlands

27–30 June 2006

Edited by Errico Armandillo, Josiane Costeraste, and Nikos Karafolas

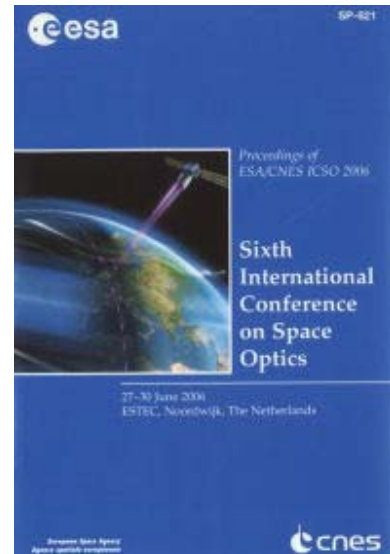

Evolution of the MOUSE II fine longitudinal sensor towards a qualification model for PEGASE mission

A. Poupinet, J. Zannis, J. G. Bossan, V. Bourrillon, et al.



EVOLUTION OF THE MOUSE II FINE LONGITUDINAL SENSOR TOWARDS A QUALIFICATION MODEL FOR PEGASE MISSION

A. POUPINET^{(1)*}, J ZANNIS⁽¹⁾, J.G. BOSSAN⁽¹⁾, V. BOURRILLON⁽¹⁾,
J.M. PELLISSIER⁽²⁾, T. VIARD⁽²⁾, C. DEVILLIERS⁽²⁾,
J. BERTHON⁽³⁾, L. MONDIN⁽³⁾, J.M. LE DUIGOU⁽³⁾

⁽¹⁾: SAGEIS-CSO, 70 avenue des Martyrs, 38000 GRENOBLE (F) ,

[*a.poupinet@sageis-cso.fr](mailto:a.poupinet@sageis-cso.fr)

⁽²⁾: Alcatel Alénia Space, 100 boulevard du Midi, 06156 CANNES LA BOCCA Cédex (F)

⁽³⁾: CNES, 18 avenue Edouard Belin, 31401 TOULOUSE Cédex 4 (F)

ABSTRACT

In the context of formation flying projects, one of the major points is the required precision on the inter-satellites distance and/or relative displacement. According to the mission, these needs are more or less restrictive, leading to the use of fine laser metrology.

Thus, for the needs of PEGASE mission [1] – a possible DARWIN in flight demonstration- SAGEIS-CSO has been asked by CNES to design a fine longitudinal sensor able to work at 120 K while performing displacement measurements at a working distance range of 25 to 250 m. Its required performances are a resolution and a precision of 25 nm.

This activity succeeds to the MOUSE II system development, which has demonstrated the ability to obtain the required laser metrology using a frequency stabilised laser, a compact and totally passive Michelson type sensor head plus a detection unit for data processing. Optical signals are routed using fibres, allowing the sensor head to be alone in a cryogenic environment.

Now, the goal is to obtain a validated prototype at a MQ level by the end of 2007.

For that, the laser source will be an update of the flight models made for IASI, using a more powerful DFB diode, pin-to-pin compatible with the previous design, and then giving minor changes. The current regulation was optimized in order not to degrade the narrow diode spectral width.

The opto-thermo-mechanical design of the sensor head, in collaboration with AAS, is also under progress, and constitutes the major evolution of the MOUSE II.

1 PRESENTATION OF THE SYSTEM

The principle of the longitudinal measurement is based on the use of an interferometric system. A Michelson interferometer splits an incoming coherent light into two arms: a measuring arm, going output to the target and reflected back, and a reference arm, staying inside the sensor head.

So, the overall system is composed of three major units: a laser source, a sensor head including the Michelson, and a detection unit for data processing. That is the minimal configuration, able to do relative optical path difference (OPD) measurements. By adding a second laser source, associated to a wavelength-demultiplexing element or by using a second optical head, it is then possible to do absolute distance metrology [2], [4].

Such a system, called “MOUSE II” [3], but not designed for 120 K, is now operating for displacement measurements at a working distance in the 25 – 250 m range (see Fig. 1).

The head contains optical parts only, meaning that only optical signals go to and come from it, routed by fibres. In this way, the sensor unit can be located in cryogenic environment whilst electronic units are in a thermally controlled area. And the use of a totally passive sensor allows not having an effect on the metrologic measurement.

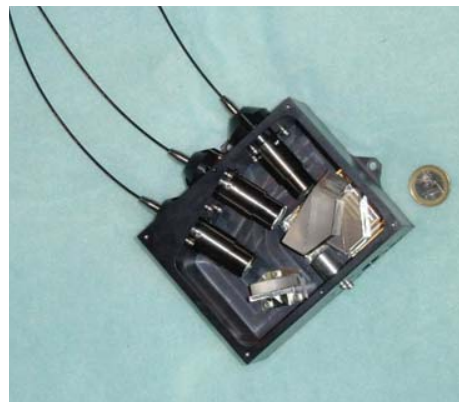

Fig. 1: Sensor head of "MOUSE II"

2 DESIGN OF THE NEW SENSOR HEAD

2.1 Optical design

In "MOUSE II", the overall interferometric function is realized using a Fresnel prism for beams separation and recombination, $\pi/2$ phase shift between s and p polarizations of reference beam [3], [4]. A Foster prism is then used to separate polarizations of the return measuring beam and the reference one, in order to obtain two optical signals called SIN and COS, necessary to know the direction of the displacement and the value of the displacement by an arctangent calculation, more accurate method than calculating an arcsinus.

The great advantage of using a Fresnel prism is to have all the major optical functions realized by a single element, which has also the advantage to equalize the BK7 path crossed by beams, making easier the sensor's assembly and allowing having a compact and robust head.

But this main component is composed of three rhombohedra, bonded together by optical glue. If these elements separate from each other, changing the refractive index at optical interfaces, their geometry is such that measuring beam can't go output. Unfortunately, no optical glue remaining clear for 1.5 μm wavelength at 120 K, approved for space flights programs in cryogenic environment, is actually known. As thermal expansion can also be a source of problem, it has been decided not to use glue at optical interfaces. Molecular adherence was not a good alternative, due to the coating for beam separation.

The Foster prism is also composed of two parts in calcite, and the glue has this time also an optical function, due to its specific refractive index allowing transmitting one polarization then reflecting the second.

In conclusion, the cryogenic environments lead us to define a new Michelson scheme. This has been done in close collaboration with Alcatel Alenia Space (AAS), in charge of the thermo-mechanical design. By iterations, optics and mechanics have progressed together in order to gain volume and mass, while keeping the system performant at ambient, during launch (vibrations, cool down to 120 K) and operational phase (vacuum, 120 K \pm 1 K, ageing), and for two distance measurement modes: relative (displacement) and absolute one (OPD).

The optical scheme obtained is the following:

- A first lens collimates the output beam of the feeding single-mode PM optical fiber,
- A splitting plate is used to form the two beams,

- On the reference beam path, a prism is used to create a phase shift between both polarizations by total reflection, with a reflecting coating at its output to send back the beam,
- On the measuring beam path, we placed a window to equalize optical paths of both beams in BK7. Its second interest is to prevent the optics from any contamination.
- After recombination of the return measuring beam with the reference one, SIN and COS signals formation is done by two calcite prisms, the first one separating s and p polarizations of both beams, the second one changing the direction of transmitted polarization.
- Finally, two others lenses focus these two interferometric signals in optical fibers, to be transmitted to the detection module.

2.2 Thermo - mechanical design

The main function of this architecture is to locate and to maintain within the specified positioning and stability accuracies every optical component along the operational environments (mechanical and cryogenic).

It is composed of the main following parts:

- The optical collimators sub assemblies, three in number with the same design. This structure allows the needed radial and axial positioning between the optical fibre and the focusing lens during the initial integration. The device is athermal in order to have the possibility to lead tests under ambient or cryogenic temperatures
- The 2 optical prisms sub assemblies. For each of them, optical elements are fixed by molecular adherence on a baseplate of the same material. Baseplates are then fixed to the optical bench.
- The optical bench itself, which is a monolithic high stable structure, closed with a cover. It is machined with local structural flexibilities in order to get quasi isostatic mounts for satellite fixation, and for optical prisms fixation.

The estimated preliminary volume is 170 mm x 150 mm x 60 mm (see Fig. 2), without collimators, for a mass of 2 kg.

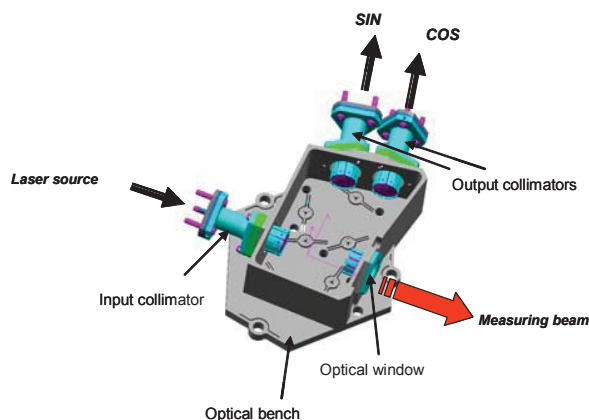

Fig. 2 : Overall mechanical structure

The choice of material and of optical component fixation technologies is backed on the expertise got by AAS from the qualified cryogenic instruments ISOCAM (operational temperature = 4 K) and IASI Cold Box Structure (operational temperature = 90 K).

3 COHERENT LASER SOURCE

The laser source associated to “MOUSE II” is an upgrade of a prototype of flight models manufactured for IASI project [5].

Its performances are key points for the longitudinal sensor:

- Its output power has to be sufficient enough to ensure correct signal to noise ratio,
- Its coherence length should allow obtaining useable interferometric fringes with an optical path difference of 500 m,
- At high working distance, its frequency stability becomes the main contributor to the accuracy budget.

That’s why the first major change was to replace the initial 1.55 μm DFB diode laser by a pin to pin compatible new one, provided by JDS Uniphase. It emits 60 mW instead of 2 mW and line width value on the order of 430 kHz is expected, the goal being to have a visibility factor at least equal to 0.1 for a 500 m long OPD.

The evolution of this visibility factor versus OPD is shown in Fig. 3, taking as hypothesis a lorentzian lineshape.

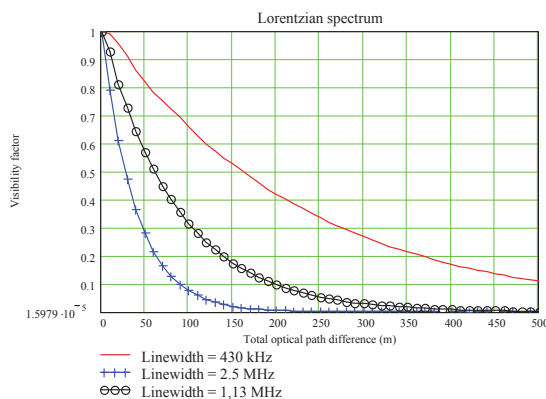

Fig. 3: Visibility factor versus OPD

3.1 Performances of up-graded laser source

The laser source is the entire system that provides a frequency locked monochromatic radiation. It includes the fibered diode laser, its current and temperature regulation, optics and electronics necessary for the servo-loop [5]. The frequency stabilization is made using an absorption peak of acetylene as frequency reference and by modulating the diode’s emitted frequency via its driving current, at 350 MHz.

Performances of the new laser are summarized in: updated MOUSE II laser source performances.

Performances	Measured values
Wavelength	1.537 μm
Optical output power	48 mW
Frequency relative stability	$4.7 \cdot 10^{-11}$ see Fig. 4
Volume	$242 \times 222 \times 50 \text{ mm}^3$
Mass	2 kg
Power consumption	6.5 W at 14 °C
Line width	2.5 MHz

Table 1: updated MOUSE II laser source performances

Comparing to IASI source performances, the increase of total power budget (6.5 W instead of 5 W) comes from the fact that the use of a powerful diode results inevitably in higher driving and thermoelectric cooler currents. As shown in Fig. 5, this value depends on the environment temperature but can be reduced by optimizing electronic components, not chosen initially for this kind of diode.

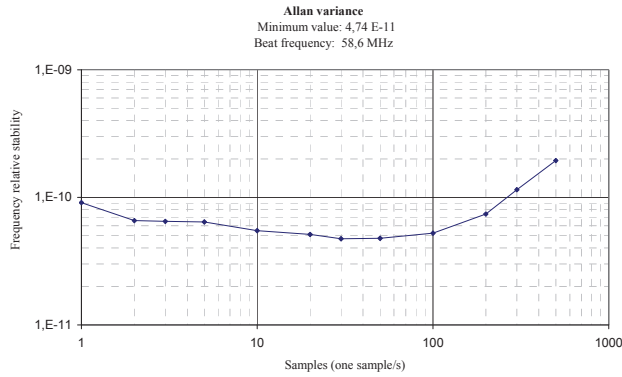

Fig. 4 : relative frequency stability

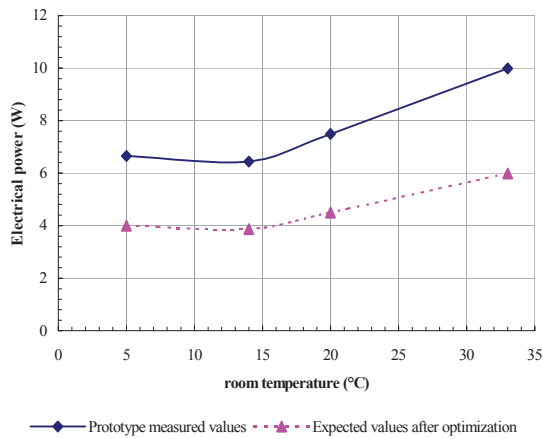

Fig. 5 : Electrical power versus ambient temperature

The linewidth value was measured during a test campaign at ONERA/CERT, using their delayed self-heterodyne setup. This method avoids the requirement of a separate local oscillator laser by taking advantage of the large optical delays obtainable with optical fibers. Incident light is split into two paths by an interferometer. The optical frequency of one arm is shift by a value of ω using an acousto-optic modulator, and the optical length of the second arm is such that the delay exceeds the coherence time of the source. Then the two combining beams interfere as if they originated from two independent lasers offset in frequency by ω .

As shown in Table 1, and according to Fig. 3, the spectral characteristics are not compliant with the need.

Going on further by doing tests with other diodes lasers and low noise laboratory current driver, it appeared:

- a. That the diode itself has a linewidth of 1.4 MHz, instead of the expected value of about 450 MHz,

- b. That its use in the laser source damaged its performances. This source was initially designed for a required value less than 15 MHz and allowed obtaining line width values of 5 MHz, the limitation coming from the diode itself.
- c. That other DFB JDS Uniphase diodes having measured linewidth between 200- 300 kHz are available.

Thus, investigations were performed to understand the origin of the deterioration of spectral performances.

3.2 Improvement of the coherence length

3.2.1 Preliminary tests based on noise measurements

The first phase was to compare electronics schemes by performing spectral analysis comparison tests.

The circuit shown in Fig. 6 depicts the existing circuit. For these tests the laser was bypassed with a short circuit, so as to prevent any damage to the Laser diode. The current was sampled through a 1 ohm resistor via a low noise screened coaxial cable, and fed into the input of a wide band electrical spectrum analyzer.

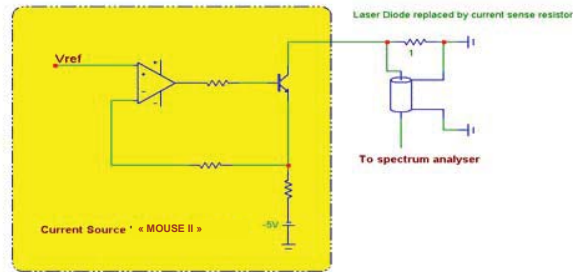

Fig. 6 : Test setup for noise measurement

Fig. 7 compared to Fig. 8 shows a great deal of noise modulating the actual laser diode current. This electrical noise modulates the laser diode, and is believed to have the effect of widening the laser optical bandwidth.

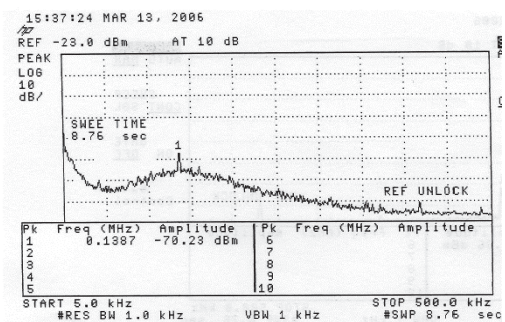

Fig. 7 : Noise Spectrum 5 kHz to 500 kHz laser ON

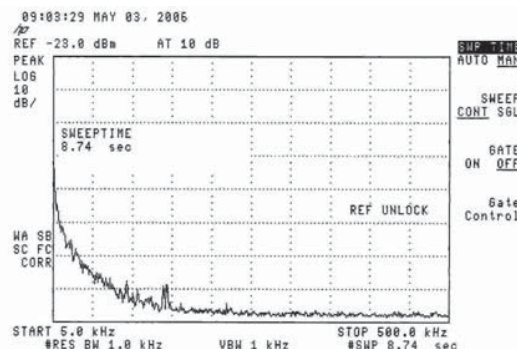

Fig. 10: New current regulation 5 kHz – 500 kHz

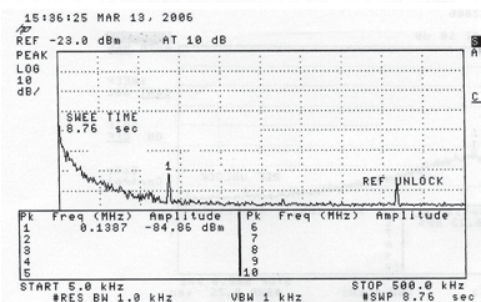

Fig. 8: Noise Spectrum 5 kHz to 500 kHz laser OFF

To solve this problem, an improved Howland-based circuit with protection was designed and tested (see Fig. 9).

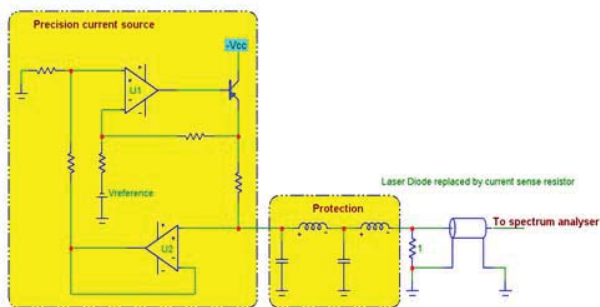

Fig. 9: New scheme for the current regulation

Electronic noise measurements shown improvements (see Fig. 10) but a series of comprehensive optical tests could then be undertaken to further qualify the two types of current sources.

3.2.2 Optical measurements

To be sure that the laser source is useable to do interferometric measurements at long distance range, the best way was to try to do it. This was done easily using a fibered Mach-Zehnder interferometer developed by IRCOM and lent by CNES.

The setup is given in Fig. 11. One of its arms has a fixed length while the second one length can be variable, allowing optical path difference until 500 m. All the fibers are polarization maintaining ones and a piezo-actuator acts on the reference arm to create small variations of the OPD. The two beams interfere on the photodiode P3 and fringes contrast can then be measured. The contribution coming from photometric budget is estimated by simultaneous measurements of optical power on each arm, deduced from P1 and P2 outputs. So, after properly calibration, it is possible to measure the variation of the contrast according to the optical path difference.

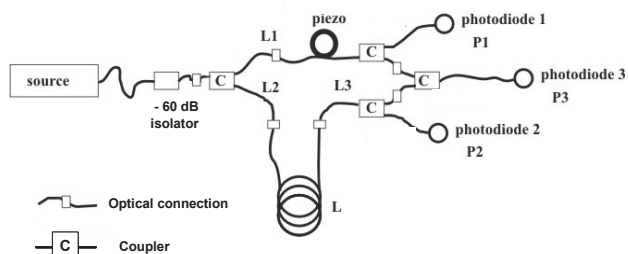

Fig. 11: Mach-Zehnder interferometer

Firstly, measurements performed using the up-dated laser source for MOUSE II, and shown in Fig. 12, have confirmed the result obtained with the self-heterodyne method (~ 2 MHz).

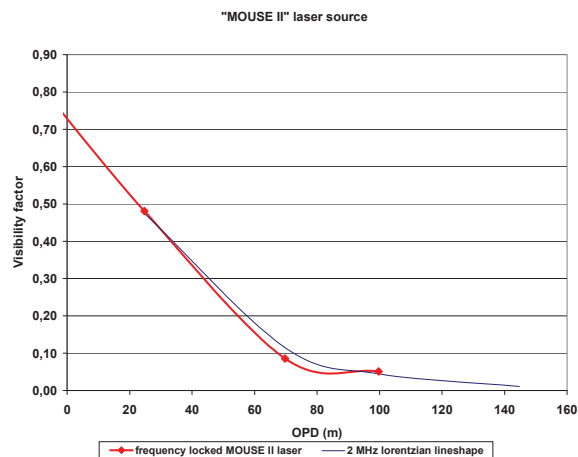

Fig. 12: Evolution of the visibility factor for « MOUSE II » laser source

Preliminary measurements have also been done using a second DFB JDS Uniphase diode, reference 500183, driven by a laboratory current regulation. Self-heterodyne method gave a linewidth of 321 kHz, value confirmed by interferometric measurements (see Fig. 13).

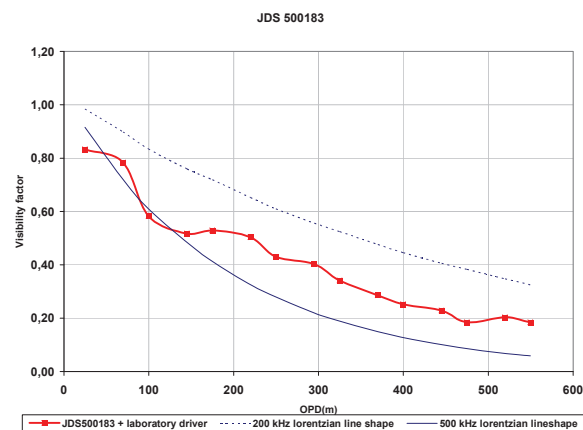

Fig. 13: Evolution of the visibility factor for JDS 500183

Secondly, the influence of the “Howland 2” circuit was tested with several diodes, resulting in improvements, as shown in Fig. 14 and Fig. 15, this last one taking also into account all the optical setup of the laser source.

Finally, the impact of the frequency modulation was also measured. Fig. 16 proves, as expected, that modulation depth damaged spectral purity of the output optical radiation due to the increased amplitude of sidebands 350 MHz apart the carrier. But the usually modulation used for IASI sources remains acceptable and we obtain a correct visibility factor of about 0.27 for an optical path difference of 500 m.

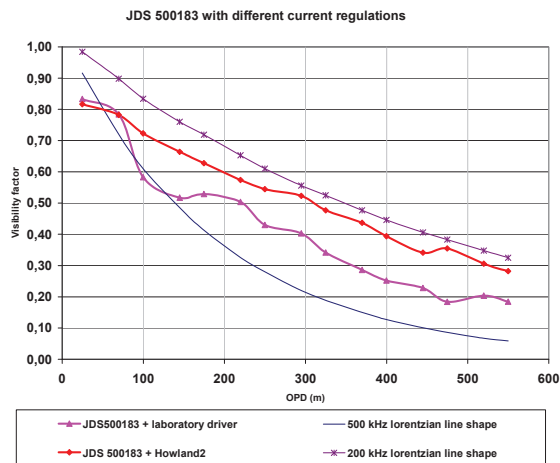

Fig. 14: Coherence improvement with JDS 500183

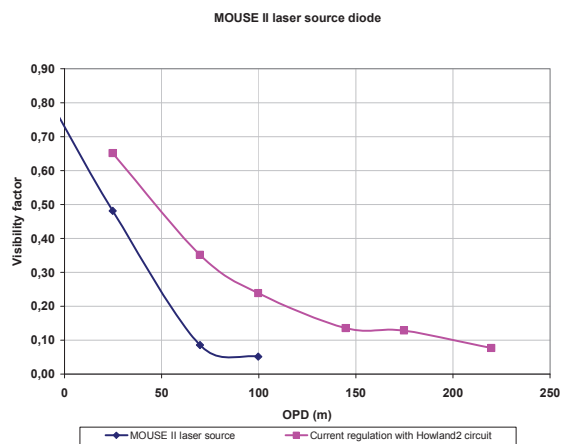

Fig. 15: Improvement with MOUSE II laser source diode

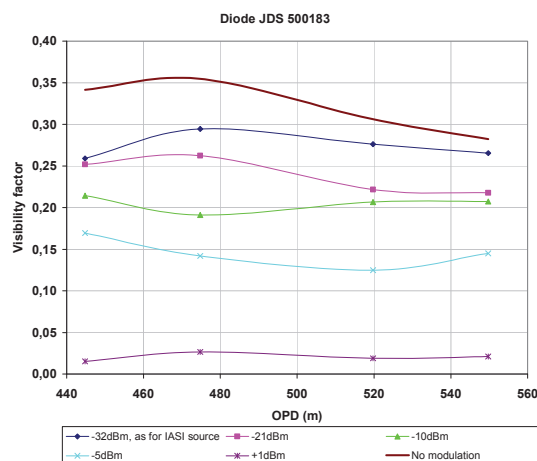

Fig. 16 : Influence of frequency modulation depth

4 EXPECTED PERFORMANCES

For the opto-mechanical design of the sensor head, tolerance calculations were made by taking into account influence of any optical misalignment on the amplitude of detected signals, especially of the measuring beam.

One interesting feature of this measuring system is that a calibration is made just before beginning measurements. Gain, offset and phase shift of SIN and COS can consequently be corrected.

Budget for integration and launch was given on the basis of the results obtained with the detection electronics developed for MOUSE II, allowing obtaining a resolution of 25 nm.

To know the maximum allowable loss to withstand with an accuracy of 25 nm during measurement, a specific simulation tool was developed.

This loss is represented by the term η , defined by Eq.1, with P_0 the initial optical power of the measuring beam and P_{loss} its new value.

$$\eta = \frac{P_0 - P_{loss}}{P_0} \quad (1)$$

The example given in Fig. 17 shows that, according to the hypothesis and for the given value of η , we do an error of 23 nm, due to the fact that the real Lissajous figure (SIN versus COS) is not the one used to perform displacement calculations.

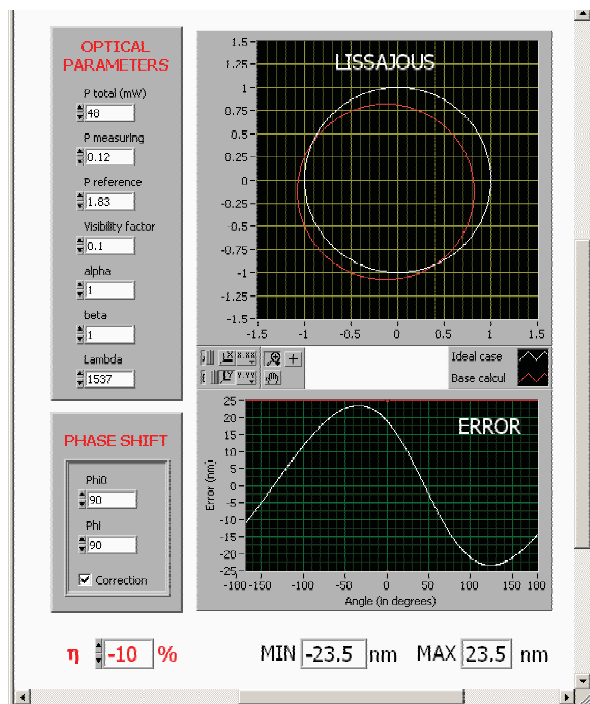

Fig. 17: simulation tool for tolerance budget

Error due to phase shift variations are also considered in the tolerance budget.

The spectral characteristics of the laser source are also of a major importance. The coherence, analysed in the previous paragraph, is taken into account in the simulation tool through the value of the visibility factor.

Finally, an accuracy of 25 nm at 250 m required a relative frequency stability of 10^{-10} , performance measured with the upgraded laser source, as shown in Fig. 4.

5 CONCLUSION

In conclusion for this first phase of definition of a fine longitudinal sensor for the needs of PEGASE mission, we can say that:

- Subject to a preliminary selection of good DFB laser diodes and implementation of a new current regulation scheme, we will have a performant laser source whose general concept has already been space-qualified,
- The opto-thermo-mechanical design of the sensor head can now operate in cryogenic environment and constitutes the main part to be qualified,
- The preliminary performances budget shows that this new longitudinal sensor is compliant with the required metrologic performances for PEGASE.

6 REFERENCES

1. Le Duigou J.M., Ollivier M. et al., PEGASE: a free flying interferometer for the spectroscopy of giant exoplanets, *Proceedings ICSO 2006*.
2. R. Thibout, L. Pujol, P. Juncar, J. Berthon, Absolute distance measurements by laser interferometry, *Proceedings ICSO 97, Toulouse, 2-4 December 97*.
3. Le Duigou J.M., Poupinet A., The MOUSE II sensors for longitudinal measurements, *Proceedings OPTRO 2005*.
4. Poupinet A., Pujol L., Berthon J., Le Duigou J.M., Laser metrology: new generation of MOUSE sensors extends distance and displacement measurement performances, *Proceedings ICSO 2004, Toulouse, 509-513, 2004*.
5. L. Pujol, Spatialized laser source frequency locked onto a molecular line, *Proceedings ICSO 97, Toulouse, 2-4 December 97*.